



# MASS FLOW CONTROLLER

EDITION 8/2012

## World leader in flow technology for over 35 years

With AERA® and SAM® Mass Flow Controllers these product ranges apply as a world leader in flow technology for over 35 years. The success is based on many properties that were in charge of developing MFC: A fast, repeatable, accurate, reliable, field-proven technology; absolute and differential pressure control, enabling

stable process control; last but not least multi-gas, multi-range, pressure-insensitive and live-gas certified MFCs. Our customers, often market leaders in their industry, verify the top quality of our products integrating both series into gas handling system solutions of the highest quality standard demand.

## Aera

Worldwide, the AERA® brand is synonymous with high-quality, high-performing designs that are backed by exceptionally responsive customer service. AERA®'s has an outstanding reputation for digital MFC reliability and performance with shipments of over 100 000 digital MFC units.

### Series R7700/R7800

AERA® 7700 delivers precise flow control, while offering the economic benefits of elastomer seals.  
AERA® 7800 shows precise flow control as well as the corrosion resistance and high leak integrity of metal seals.

### Series DR980

AERA® DR980 deliver performance excellence and operational versatility.

### Series Transformer®

AERA® Transformer will transform your process, providing superior flexibility and efficiency for improved yield, higher productivity, and lower cost of ownership.

### Series PI-980®

The AERA® PI-980® pressure-insensitive MFC's anticipate the increasing demands of next-generation manufacturing and reduce gas panel footprint and cost.

## SAM

From the release of the first of our MFCs, SAM® brand high-performance mass flow controllers continue in the tradition of perfection. High corrosion resistance and stable control performance are possible thanks to our waveform diaphragm made of Ni-Co alloy.

### SERIES F

SAM® controllers that are equipped with these technologies enjoy a well deserved reputation from globally recognized customers. Real SAM®-brand products are highly valued as premium performance design.

### Series FX

While inheriting the tradition of our earlier Mass Flow Controllers, the FX series is a bold advance into the next generation. The major element of innovation is the combination of technologies derived from the G series. Not such advanced as G with its full scale PI function, they have greater PI performance as the F series.

### Series G

This SAM® G design is positioned to play a major role in the next generation of controllers. The G series is an all-in-one mass flow controller that meets or exceeds the next generation of requirements, a step ahead of the competition. These advances are in response to our customers' needs for high level functions.

## Most frequently requested gas types

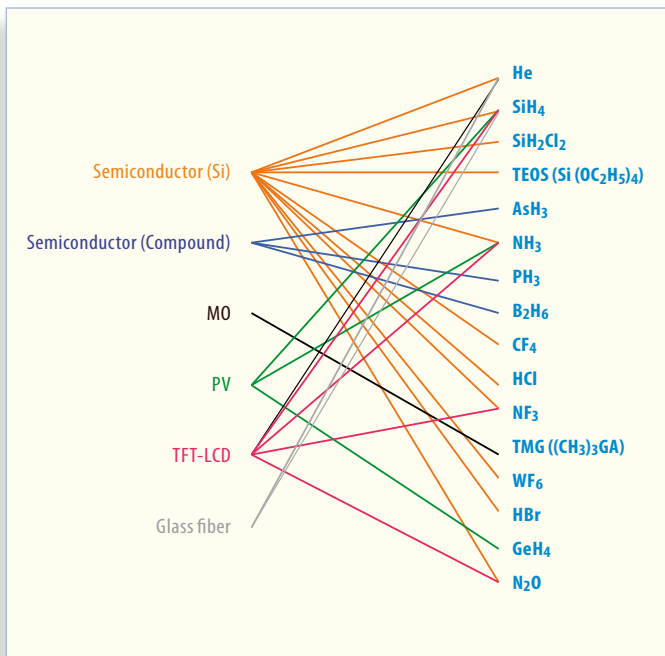

## AERA TECHNOLOGY DEVELOPMENT

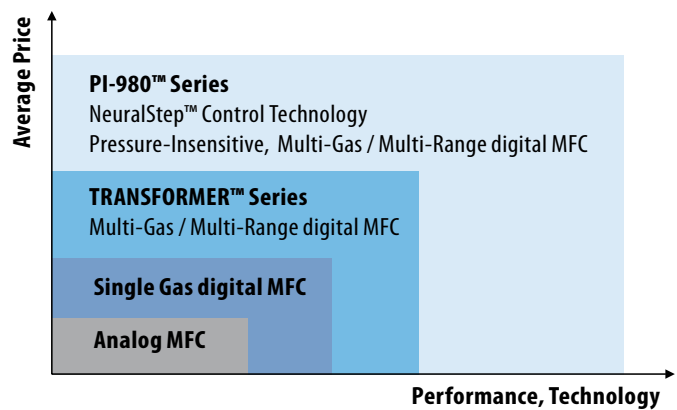

## MFC Application Areas

Analytical Instruments, Biopharmaceuticals, Catalysis, Cell culture and fermentation control, Chemical Engineering, Fiber optics, Fuel cells, Glass coating, Industrial, Life Sciences, Medical device, Modified Atmosphere Packaging (MAP), Optoelectronics, Petrochemical, Photovoltaics, Process Industry, Quality control, Semiconductors, Solar cells, Surface Technology.

**Now designed to play a major role in next generation of controllers**

**MFC QUALITY AND PRECISION**

**ACCURACY - REPEATABILITY - HIGH LEAK INTEGRITY - TEMPERATURE STABILITY - LOW ZERO DRIFT - SPEED**

AERA® and SAM® Mass Flow Controllers enjoy a well deserved reputation from globally recognized customers. They are valued as a premium performance design. Advanced products have been developed in close contact with our customer's needs for functions meeting or even exceeding the next generation of requirements of high performance and highest product quality: Multi-Range and Multi-

Gas functionality, guaranteed control accuracy with the actual gas, Pressure Insensitivity function and built-in Shut-Off-Valves. Complete Digital Remote Control with extended program functionality like Flow-Rate-Verification are appropriate steps to receive ongoing good marks from our customers caused from limiting investment and precise flow control.

**Thermal Sensor Technology**

**Flow sensing**

- ▲ Consists of two heated resistance wires wound around the outside of a thin walled capillary tube.
- ▲ The resistance of the coils is known at given temperatures.
- ▲ The coils are connected in a bridge circuit and supplied with regulated current.
- ▲ Changes in the bridge resistance are related to mass flow rate, thus creating the basis value for control.

Our flow rate sensor, another key component in MFC's, employs a coil type thermal sensor based on technology we have been accumulating for half a century, thus resulting in extreme reliability.

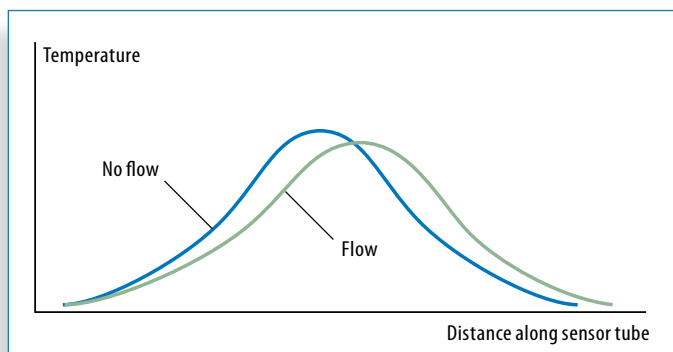

Fig.: Flow and temperature change

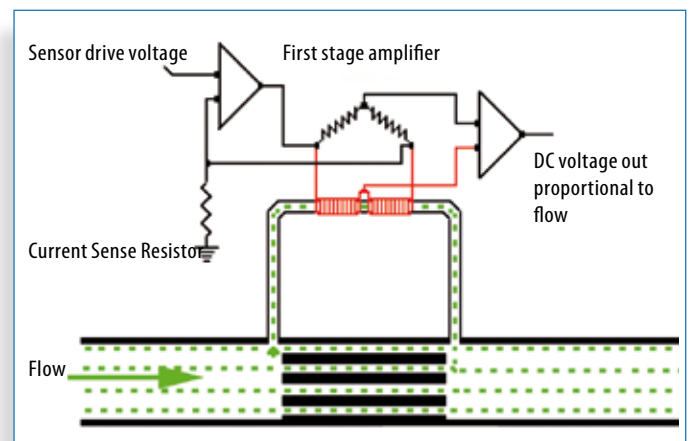

Fig.: Flow measuring with wheatstone bridge

**System Solutions**

Gas handling applications vary f.e. from flame control over atmosphere control to plasma control. Precise gas and gas mixtures mass flow into process chambers therefore enable sophisticated gas treatment for high end products to be manufactured. Because the need of a flow rate guarantee to be able to generate reproducible processes is absolutely indispensable, AERA® and SAM® system engineering delivers convincing packages. Modular, compact installations, leak proofed device, highly developed multifunctionality systems are - not really surprising - future proofed and a safe investment.

**Gas panel technology trends**

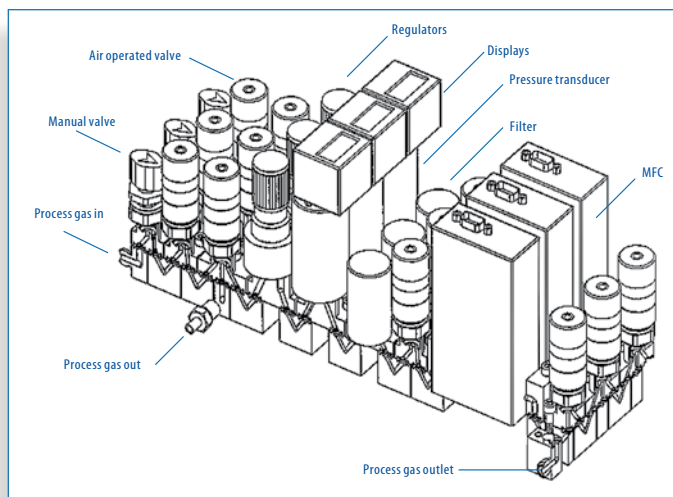

Fig.: System integration with modular, compact installations

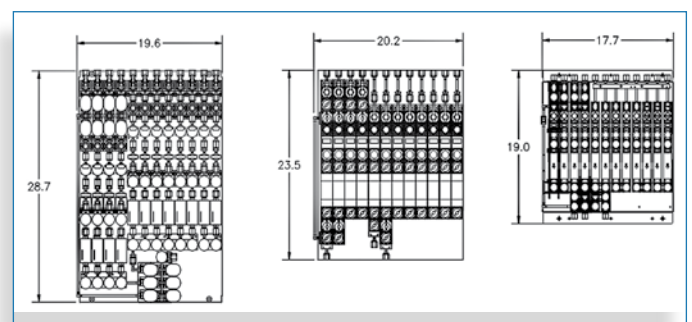

Fig.: Progressive system miniaturization

### Control - Consoles - Connectors

Depending on the model, the set point value and actual value signals can be predefined and fed back either by analog or digital communication: analog via standard signal interface or digital via RS-232/RS-422 or field bus interface (Profibus, Device Net, Ethernet). The digital RS-232 or RS-422 interface is required for communication with the Mass Flow Controller software (device dependent). The microprocessor controlled electronics provide significant benefits: they reduce drift and offset occurrences of the components and enable software-based control of the most important processes. The relevant data for this (calibration curves, correcting functions, control functions, etc.) can be stored in the memory. Operator consoles are available in two different models (RO 120, ROD-4A) - each one suitable for certain functions and number of control channels.

Single channel unit: RO 120 Readout Unit is capable to supply power to a single MFC, controlling flow rate and providing readouts of the flow rate.



Multi channel unit: The ROD-4A is an operating unit for up to four mass flow controllers in combination with analog or digital MFC, which correspond to the available connections. The operation can be executed via keypad at the front panel of the device or interface RS232 via PC alternatively. In order to maintain the preset mixture of gases at changing flow rates the ROD-4A has a master/slave function.



Fig.: Readout units RO 120 and ROD-4a front view

### Field Programmability

The Programming Window allows to be configured the connected MFC recognized on the Search Window.

This window allows you to send a gas type, CF type and full scale to an individually specified MFC. Reading the configured data in the MFC, printing the read data and reading/writing data file is also available on this window.

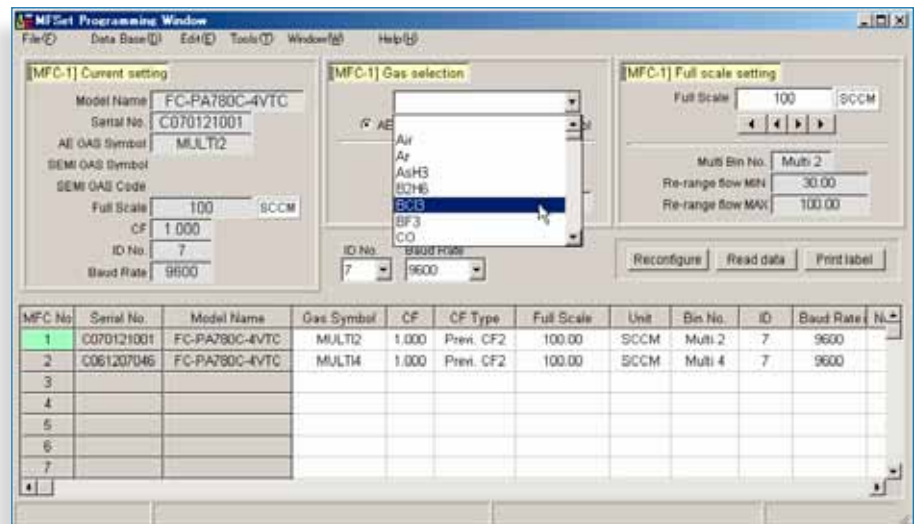
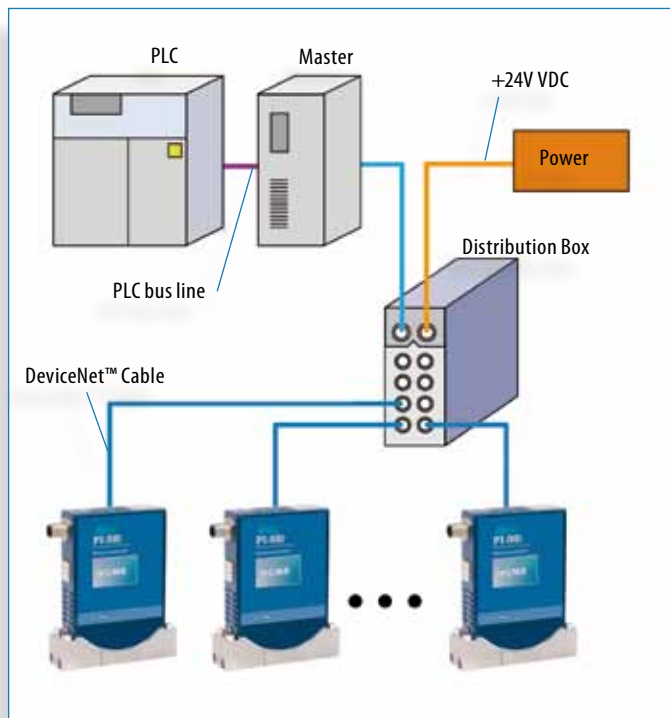

Fig.: GUI Programming window

### DeviceNet™ Communication DN



DeviceNet™ is a field network world wide recognized, and it is approved as a standard sensor bus by the SEMI. Field devices can be connected using serial communication in place of an I/O connection, allowing transfer of a large volume of data effectively. The DeviceNet™ specifications are administrated by the ODVA (Open DeviceNet™ Vendor Association, Inc.) a non-profit body established to promote the spread of this system world-wide.

#### Benefits

- No need of AD / DA / O board which can decrease configuration and set up costs.
- Only network cables are needed reducing cabling costs.
- With power supply of +24 VDC no need of ±15 VDC for MFC.
- DeviceNet™ specifications follow international standards opening lots of control devices available from multiple vendors.

Fig.: DeviceNet connected device

## Pressure Insensitive Function **PI**

The PI (Pressure Insensitive) function improves the controller's ability to tolerate variations in the primary pressure. This function improves durability and is currently highly desired in mass flow controllers.

Upstream gas supply pressure changes may cause ordinary mass flow controllers to fluctuate in pressure because the MFC tries to maintain control as it detects pressure change at the flow rate sensor. Therefore, any current mass flow controller, without this regulator, is directly influenced by fluctuation in the gas supply inlet pressure, and the actual flow rate will change instantly by a large amount.

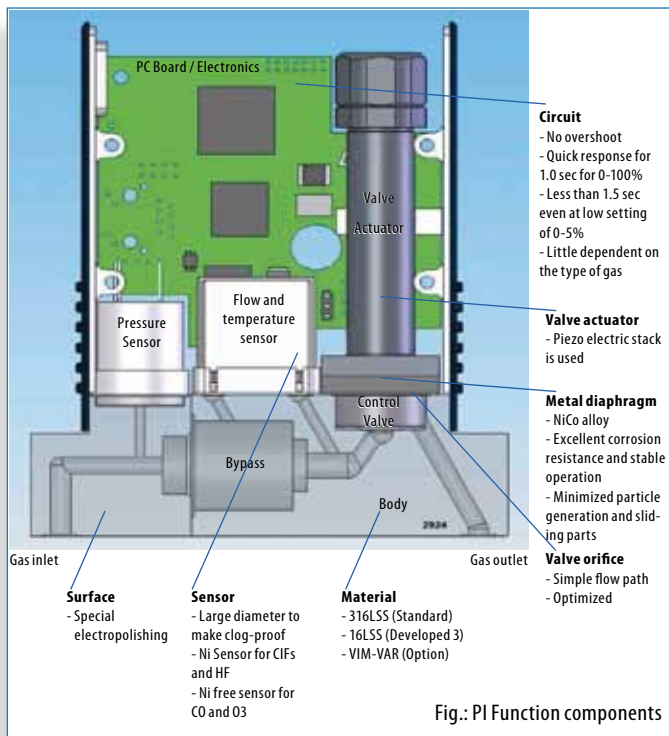

### PI Benefits

- Smaller fluctuations in the actual flow rate
- More stable gas flow to the chamber improves process results and yield
- Faster response enables new processes and faster throughput

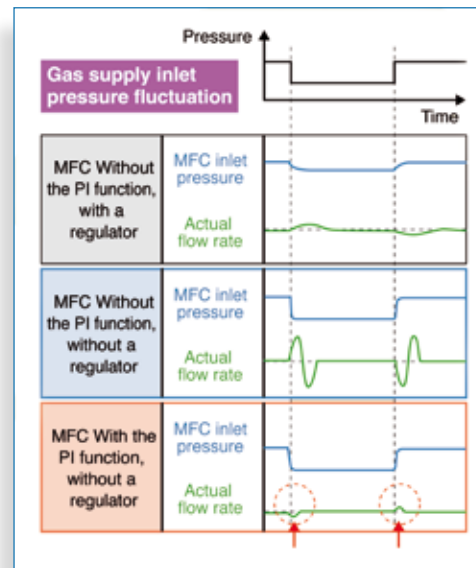

Fig.: PI function and pressure fluctuation

### How does a PI-function work?

An additional pressure sensor measures the fluctuations in gas pressure before it reaches the flow sensor.

Then NeuralStep - an additive control algorithm - makes the valve adjustment to keep the flow stable and accurate before the pressure fluctuation reaches the flow sensor. This interrupts the feedback from the flow rate sensor to the control valve, and keeps the control valve opening at an optimum level..

### What is the result of PI-function?

Output flow rate and pressure change will be significantly reduced in both the amount and timing. Downstream processing will be less influenced.

## Multi-Gas / Multi-Range Function

## MG/MR

A conventional mass flow controller only guarantees the flow rate accuracy with N<sub>2</sub> gas and one controller would only handle one type of gas and one full scale flow rate range. This means, that customers need to have a dedicated mass flow controller for each system, and for each process recipe.

To get the flow rate conditions for your actual gas using a conventional MFC, a conversion factor must be used as a coefficient to convert the flow rate. The reference values for these coefficients have been based of a variety of values, including calculated values, actually measured values, and empirical values. And, these were merely guidelines or reference values with some gas types.

With flow controllers equipped with the MG/MR function, you can have up to a lot of user recipes to match the intended flow range, and you can change the gas type and flow rate to match the actual gas you want to handle by changing the metering conditions instantly connecting the MFC to a personal computer.

Our actual gas flow rate accuracy warranty system backs up this MG/MR function. With MG/MR mass flow controllers, in addition to the flow rate reference for N<sub>2</sub> gas (that ensures conformance with the national standard using the conventional gravimetric method), we installed full scale actual gas metering and exhaust gas processing facilities at our factory. Using these facilities, measurement is made for each type of gas at each full-scale range, and record the data. This is then used as actual gas data.

### Simple use of the MG/MR conversion program

Gas type and flow rate can be converting using an MG/MR with a simple GUI interface conversion program. Connect the mass flow controller to a personal computer using a digital communication cable, first select the gas type, and then flow rate units. A the flow rate range will appear, change it and the setting is complete.

### Benefits

- Allows one mass flow controller to handle two or more gas types and ranges
- The need for dedicated devices is reduced to only a few models
- Reduces the capital investment and inventory liability
- Performance (precision and response) can be maintained after gas change
- MG/MR is the biggest achievement that digital technology brought to MFC

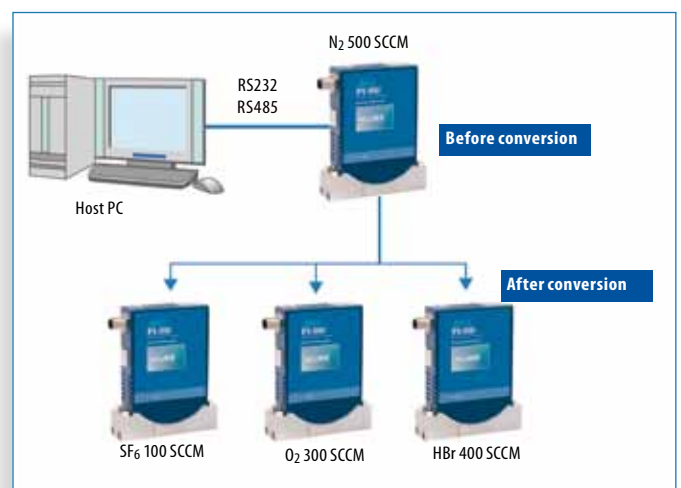

Fig.: MG/MR driven device simplification

## Valve Shut-off Function **VSO**

Available only for series

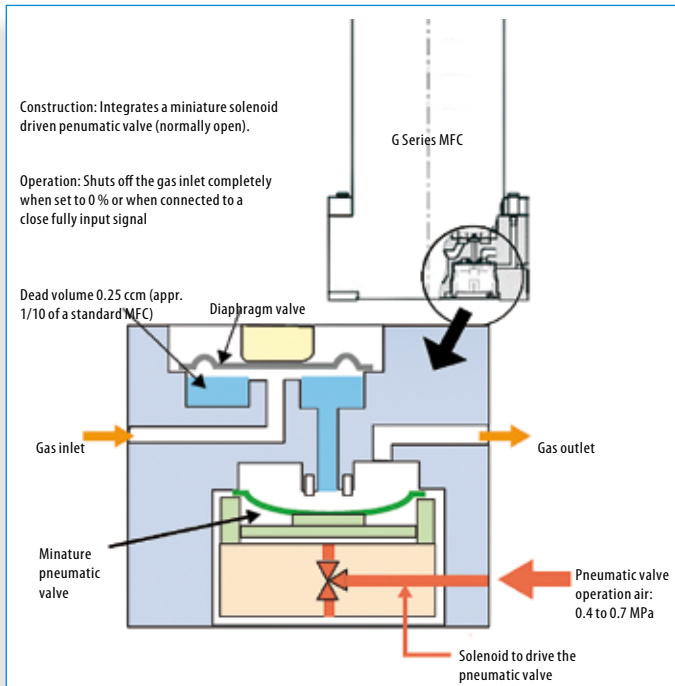

Fig.: Example - G2 Series construction

The major purpose of the valve-shut-off function is to reduce the gas purge time that is required to vent residual gas in the space between the downstream pneumatic valve and the mass flow controller valve. The ordinary flow rate control valve installed in a mass flow controller cannot shut-off the gas completely. In order to overcome this problem, a valve is integrated near the downstream flow rate control valve, to enable the Valve Shut-off Function. This pneumatic valve is a normally fully open type. It absolutely shuts off all gas with a setting of 0% or when a close fully signal is received. Also the volume of gas leaking (that could cause a gas surge) will be approximately 1/10 that in a combination of an ordinary mass flow controller and pneumatic valve.

### Benefits

- VSO reduces the gas purge time
- Reduction of gas that can surge into a chamber
- Shorten the gas purge time needed to achieve a stable flow rate
- Provides productivity improvements
- Reduces the amount of wasted expensive gas

## Flow Rate Verification Function **FVF**

Available only for series

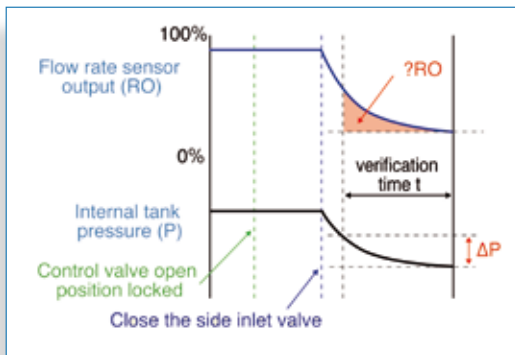

Fig.: Flow rate verification

Flow rate verification is a method for verifying changes in the flow rate over time. It compares reference data for normal operation when starting to the current flow rate verification results at certain intervals.

### Operation

A tank with an integrated pressure sensor and a side inlet valve are the main items used for verification. At the beginning of the verification the MFC temporarily stops the normal flow rate control and locks the opening position of the flow rate control valve. Next, the side inlet valve closes.

The chart below shows the relationship between the internal tank pressure P and the flow rate sensor output RO, with time on the horizontal axis and pressure and output on the vertical axis. After closing the side inlet valve, P and RO change as shown below. The amount of flow rate deviation (the verification value), can be obtained from the ratio between flow rate when starting to use the MFC, and the results of the verification calculation after a certain period has elapsed.

Operation uses a special program on a personal computer. Another method is a stand alone operation using the MFC by itself. With this method, the zero reset switch on top of the main housing is used for the verification and the verification results are shown on the LCD. This method does not need a personal computer. The third method controls the operation with commands from a system.

In any of these methods, the basic operation procedures are the same. You can easily calibrate a periodically verified flow rate.

### Benefits

- You can identify risks that might otherwise cause significant damage to your products
- Verifying changes in the flow rate over time
- Verification can be checked on a personal computer display or on the LCD
- Prolongs the life of the mass flow controller
- Contributes to maintaining planned maintenance cycles

The requirements for flow rate accuracy and repeatable performance of MFCs are constantly growing. In manufacturing semiconductor devices, where process margins are tight and stopping operation of the devices is not allowed, it must be possible to evaluate the performance of the mass flow controller without removing it from the gas circuit.

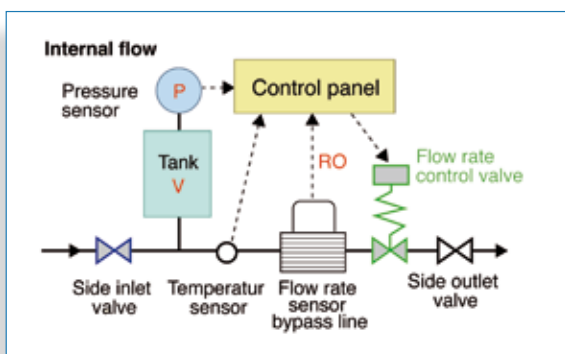

Fig.: Flow calibration

## Analog Mass Flow Controller FC-R7700

Precise, economical, elastomer-sealed design.

As the field-proven standard for a range of applications, AERA® FC-R7700 series delivers precise flow control, while offering the economic benefits of elastomer seals.

### Features

- Elastomer seals
- VCR®, VCO®, and Swagelok® compatible connections
- Full-scale flow ranges from 10 SCCM to 200 slm
- Normally-closed or normally open solenoid control valve
- Leak integrity of  $1 \times 10^{-6}$  atm-cc/sec of He



### Highlights

For process and equipment engineers working in the semiconductor, flat panel display, data storage, industrial vacuum, and industrial coating markets, this series provides high reliability and superior performance for non-corrosive gas applications, including CVD, PVD, etch, ion implantation, sputtering, thermal oxidation, optical glass coating, optical fiber, surface treatment, and other coating processes.

### Benefits

- Fast response < 2 sec flow setting time between set points
- Easy integration - standard connectors and dimensions

## Analog Mass Flow Controller FC-R 7800

Precise, reliable, metal-sealed corrosion resistant design

AERA® FC-R7800 series delivers precise flow control, as well as the corrosion resistance and high leak integrity of metal seals, to suit the majority of gas-controlled applications.

Convenience-enhancing features, such as standard electrical connectors and standardized critical dimensions allow quick-and-easy replacement of existing mass flow controllers (MFCs).

### Features

- Metal seals
- Corrosion resistance
- VCR®, VCO®, and Swagelok® compatible connections
- Full-scale flow ranges from 10 SCCM to 200 slm
- Normally-closed or normally open solenoid control valve
- Leak integrity of  $1 \times 10^{-10}$  atm-cc/sec of He



### Highlights

Corrosion resistant design. Superior results - high-quality thin-film characteristics. Suits the majority of gas-controlled applications. Convenience-enhancing features, such as standard electrical connectors and standardized critical dimensions allow quick-and-easy replacement of existing mass flow controllers with no installation hassles.

### Benefits

- Fast response < 1 sec flow settling time between set points
- Easy integration — standard connectors and dimensions
- Outstanding reliability
- Superior results — high-quality thin-film characteristics

## Digital/Analog Mass Flow Controller FC-DR980

Leading digital Multi-Gas/Multi-Range MFC, providing superior versatility in various systems.

AERA® FC-DR980 series deliver performance excellence and operational versatility, resulting in significant cost savings and ease of use.

### Features

- Multi-Gas/ Multi-Range selection
- Multi mode operation: analog, analog/digital and digital modes for operation with any control system
- Highly sensitive, rapid response and small diameter sensor
- Piezoelectric control valves
- Multiple alarm and diagnostic capabilities
- Metal seals with a leak integrity of  $1 \times 10^{-10}$
- Electro-polished and ultra-cleaned gas-wetted surfaces



### Implemented Functions

# MG/MR

### Highlights

Easily field-programmable to run various gas types. For quick gas and full-scale reassignment.

Multiple output options enable analog or digital control. For comprehensive monitoring and control capabilities, RS-485 communications (RS-232 with converter), combined with a full range of diagnostic and alarm functions, put operational parameters at your fingertips.

### Benefits

- Superior accuracy, repeatability and stability
- Significant cost savings
- Superior operational versatility
- Superior reliability

## Digital/Analog Mass Flow Controller TRANSFORMER

Transforms your process with greater flexibility and lower cost of ownership.

Suitable for a variety of applications, including CVD, PVD, diffusion and etch, TRANSFORMER mass flow controllers (MFCs) and mass flow meters (MFMs) will transform your process, providing superior flexibility and efficiency for improved yield, higher productivity, and lower cost of ownership.

### Features

- All-metal seals and ultra-pure design
- Multi-gas, multi-range selection
- Fast response
- Field programmable
- Wide range of gas selection without recalibration
- Long term zero point stability
- Multiple alarm and diagnostic capabilities

### Benefits

- Outstanding accuracy, repeatability, and stability
- Superior reliability
- Comprehensive communication and control
- Easy integration
- Substantial cost savings
- World-class service and support
- Just eight multi-gas, multi-range Transformer MFCs can replace hundreds of spares and part numbers



### Implemented Functions

# MG/MR

### Highlights

Advanced sensor and valve technology, field-proven platform components and high-speed, digital circuitry deliver very precise gas flow control. TRANSFORMER enables film deposition and etch characteristics that are not only extremely uniform, but also highly repeatable. Designed with field-proven AERA® platform components and high-speed digital circuitry, Transformer has achieved superior reliability performance with < 0.5% zero drift over one year and superior repeatability of 0.2% of full scale. Comprehensive communication and control functions include flow, valve and CPU alarms, gas-flow totalizing and ramping control, system override capabilities and in-situ gas and range customization. TRANSFORMER'S outstanding technology capabilities reduces overall costs by cutting inventory requirements (Just 8 TRANSFORMERS can replace hundreds of spares and part numbers).

## Digital/Analog Mass Flow Controller FC-PI 980

Next-generation PI technology for tomorrow's manufacturing demands.

With industry-leading flow control technology, AERA® PI-980 Series pressure-insensitive MFCs anticipate the increasing demands of next-generation semiconductor manufacturing processes, including etch, CVD, PVD and diffusion.

### Features

- All-metal seals and ultra-pure design
- Pressure-insensitive operation
- Integrated self diagnostics
- High accuracy and repeatability
- Integrated gas panel components
- Live gas certified, multi-gas, multi-range configuration
- Field programmable
- DeviceNet™, RS-485, and analog control

### Implemented Functions

# PI



### Highlights

This innovative technology platform provides faster response, greater gas-flow stability and superior real-time process control when compared to previous technologies. High-flow stability delivers greater chamber-to-chamber process repeatability for improved production yields. Its design integrates traditional thermal flow architecture with a pressure and temperature sensor, and Neural Step control technology. This creates a single, compact delivery package, eliminating the need for a number of costly gas panel components traditionally utilized. Multi-gas, multi-range functionality dramatically reduces supporting inventory requirements, further enhancing cost efficiency. In addition to integrated diagnostics, this next-generation MFC technology has been combined with our field-proven D980 series product platform design to increase system uptime and make trouble shooting quick and easy.

### Benefits

- Improved gas delivery performance and production yields
- Easy integration on tool
- Substantial gas panel cost savings
- Reduced gas panel footprint
- Real-time communication and control
- World-class service and support



## Overview Mass Flow Controllers **Aera**

Model	FC-R 7700	FC-R 7800	FC-DR980	Transformer	FC-PI 980
<b>Type</b>	Analog MFC	Analog MFC	Analog/digital MFC	Analog /digital MFC	Analog/digital MFC
<b>Short</b>	Precise, economical, elastomer-sealed design	Precise, reliable, metal-sealed design	Providing superior versatility in various systems	Transform your processes with greater flexibility and lower cost of ownership	Next-generation PI technology for tomorrow's manufacturing demands
<b>Functions</b>			MG/MR	MG/MR	PI
<b>Control modes</b>	Analog 0 - 5V	Analog 0 - 5V	Analog 0 - 5V / DeviceNet™ and RS485	Analog 0 - 5V / DeviceNet™ and RS485	Analog 0 - 5V / Ethernet, DeviceNet™ and RS485
<b>Specialties</b>		Corrosion resistant design. Superior results - high-quality thin-film characteristics.	Multiple alarm & diagnostic capabilities. Multi-gas, multi-range, multi-mode.	Field programmable. Wide range of gases without recalibration. Comprehensive communication and control	Pressure insensitive. Superior real-time process control. Real time communication and control. Live gas certified.
<b>Flow range</b>	0,01-200 SLM	0,01-200 SLM	0,01 - 50 SLM	0,01 - 30 SLM	0,005 - 100 SLM
<b>Normal operating pressure</b>	5 bar / 70 psi	5 bar / 70 psi	5 bar / 70 psi	5 bar / 70 psi	7 bar / 100 psi
<b>Response time</b>	< 2 sec	< 1 sec	< 1 sec	< 1 sec	< 1 sec
<b>Accuracy</b>	< 1,0 % of FS*	< 1,0 % of FS*	< 0,25% FS/ 1% of SP**	< 0,25% FS/ 1% of SP**	< 0,25% FS/ 1% of SP**
<b>Stability</b>	< 0,5 % / 1 % of FS*	< 0,5 % / 1 % of FS	Superior < 0,5 % of FS	Superior < 0,5 % of FS	Superior < 0,5 % of FS
<b>Repeatability</b>	< 0,2 % of FS	< 0,2 % of FS	< 0,15 % of FS	< 0,2 % of FS	< 0,25 % of FS
<b>Sealing</b>	Elastomer design	Metal design	Metal design	Metal design	Metal design
<b>Leak integrity</b>	1x10 <sup>-6</sup> atm-cc/sec of He	1x10 <sup>-10</sup> atm-cc/sec of He	1x10 <sup>-10</sup> atm-cc/sec of He	1x10 <sup>-10</sup> atm-cc/sec of He	1x10 <sup>-10</sup> atm-cc/sec of He
<b>Connections</b>	VCR®, VCO® and Swagelok® comp.	VCR®, VCO® and Swagelok® compatible	VCR®, IGS (C or W seal)	VCR®, IGS (C or W seal)	VCR®, IGS (C or W seal)
<b>Control valve</b>	NO or NC solenoid	NO or NC solenoid	NO or NC piezoelectric	NO or NC solenoid	NO or NC piezoelectric
<b>Alarm and diagnostics</b>			Multiple capabilities	Multiple capabilities	Multiple capabilities
<b>Easy integration</b>	Standard connectors and dimensions	Standard connectors and dimensions		Replacing other brands—with no installation hassles	Easy integration on tool
<b>Cost aspects</b>	Effective and precise design	Allows quick-and-easy replacement of existing mass flow controllers	Dramatically reduction of spare inventory	Reduces overall costs by cutting inventory requirements, can replace any other MFC used in the process, regardless of gas type	Substantial gas panel cost savings. Increasing system uptime and make troubleshooting easy

\*) FS = Full scale, value depends on model. \*\*) SP = Setpoint, value depends on setting: <25% of FS: 0,25 % of FS, 25-100 % of FS: 1% of SP.

### Response or Settling Time

The time that it takes, for actual flow, it to stabilize after a set point change has been made.

### Repeatability

Another primary factor is the repeatability of actual flow for an MFC or from one MFC to another at any set point.

### Linearity

Linearity is the straightness of the curve of actual flow vs. set point, in other words, accuracy over the entire flow range.

### Stability

Stability refers to the ability of an MFC to maintain

stable flow levels through short-term effects such as pressure and temperature changes, and through long-term effects such as aging of the component parts.

### Zero Drift

Zero drift is the most common complaint of MFC users. It is a time-dependent shifting of the zero calibration point from its original zero value to an offset value, and is generally caused by aging effects of various electrical components on the PC board as well as by aging of the sensor windings. The aging phenomenon that results in zero drift not only causes a shift in the zero calibration point but also a shift of the entire curve of control voltage vs. flow.

Zero drift has been essentially eliminated in AERA® flow products. The typical zero drift of our MFCs is less than 0.5% of full-scale flow over a period of one year. This is the result of using the highest-quality sensor wire and electrical components on the PC board. Perhaps more importantly, the sensors assembled in our MFC, are subjected to extreme burn-in procedure and stringent, multiple QC inspections to screen out all marginal components.

Thus means, we do not hide the zero drift move, we prevent it.

Digital/Analog Mass Flow Controllers series SFC-F



SFC-F is the basic series of compact digital MFCs.

Features

- Diaphragm direct sealing valve
- Original digital control method
- High accuracy by digital multi-point calibration
- High accuracy at low flow set-points
- Long-time stability of zero
- Minimized dead space
- No need to switch gas piping
- A wealth of data resources available
- Very low differential pressure < 10 Torr available
- Simple valve structure allows high Cv-value reserve despite compact dimensions

Benefits

- Outstanding control characteristics
- Large amounts of data are available
- MFC selection according to service gas type, operation pressure and temperature conditions

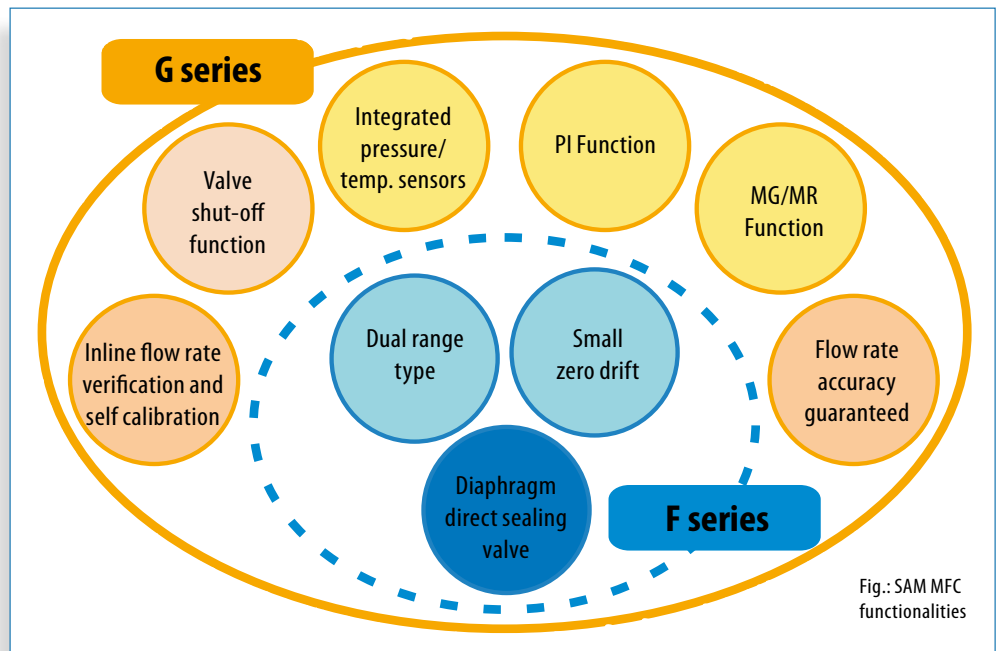

Fig.: SAM MFC functionalities

All in One Functionality

With SAM's advanced technologies, such as its reliable diaphragm valve structure, digital control, etc., the G series offers innovative features that can be used for a variety of new functions. Hitachi Metals is developing a product lineup that best meets user's needs, such as an all-in-one mass flow controller that includes all the functions along with models that include only desired functions.



Sectional View

The G series controllers are all-in-one mass flow controllers ready for the next generation of requirements for guaranteed accuracy with the actual gas, MG/MR, PI, valve shut off, and flow rate verification.

Fig.: Sectional view with diaphragm

## Series SFC-1480F

SFC-1480F Series is a basic series of compact digital Mass Flow Controllers offering very low flow.

### Features

- Very fast response < 0,7-1,2 sec flow settling time
- Metal / rubber seals
- Flow 1 SCCM - 20 SLM (12 models available)
- Leak integrity <  $1 \times 10^{-11}$  Pa m<sup>3</sup>/s He (Viton 10<sup>-8</sup>)

### Benefits

- Monitoring of operation using digital interface is possible
- Minimal particle generation
- Long operation life



## Series SFC-1580/1680F

SFC-1580/1680F series is the high temperature version of compact digital Mass Flow Controllers.

### Features

- Higher operating temperature 150 °C
- Built-in structure to prevent recondensation
- Fast response < 1 sec flow settling time
- Metal seals
- Flow 10 SCCM - 30 SLM (14 models available)
- Leak integrity <  $1 \times 10^{-11}$  Pa m<sup>3</sup>/s He

### Benefits

- Application into high temperature processing
- Easy integration - standard connectors and dimensions

### Highlights

A separate control unit with heat proofed connection, a lower sensor heating temperature, and high temperature piezo-stack are used. A simple valve structure, which does not compress and expand gas, prevents re-condensation.



MFC F Series with separate Control Unit SCU 1500

## HIGHER OPERATING TEMPERATURES

## Series SFC-1480/2480FX

This highly advanced SAM® brand model with advanced sensor and valve technology, field-proven components and high-speed, digital circuitry delivers precise flow control even at very low flow rate down to 1 SCCM.

### Features

- Multi-gas, multi-range selection
- Pressure-insensitive operation
- Diaphragm direct sealing valve
- Extremely reliable coil type thermal sensor
- Guaranteed precision
- Extremely corrosion-proof with stable control waveform NiCo alloy diaphragm
- Unique, special electro-polished surfaces
- High corrosion resistance
- Low flow rates available (1 SCCM)
- Comprehensive alarm functions

### Highlights

Designed with field-proven components and high-speed digital circuitry, FX has achieved superior reliability performance with < 0.5 % zero drift over one year and superior repeatability of 0.06 % of full scale. Comprehensive communication and control functions include flow, valve and CPU alarms, gas-flow totalizing and ramping control, system override capabilities and in-situ gas and range customization. FX's outstanding technology capabilities reduces overall costs by cutting inventory requirements.

### Implemented Functions

# MG/MR PI

# DN



### Benefits

- Outstanding accuracy, repeatability, and stability
- Impressive alarm and diagnostic functions
- Comprehensive communication and control
- Superior reliability flexibility
- Greater flexibility and lower cost of ownership

## Overview F Series **SAM**

Model	SFC 1460 F	SFC 1470 F	SFC 1480 F	SFC 1580/1680 F	SFC 1570/1670 F
<b>Short</b>	Compact low flow model	Compact quick response models	Compact quick response models	High temperature, quick response models, re-condensation preventing	High temperature, quick response models
<b>Flow range</b>	0,001-0,01 SLM	Flow customer specified	10 - 20 SLM	0,01-30 SLM	Flow customer specified
<b>Specialties</b>	Very low flow, vacuum serving. Minimized dead space and particle generation.	Very low differential pressure less than 0,2 psi. Minimized dead space and particle generation.	Very low flow, vacuum serving. Minimized dead space and particle generation.	Very low flow, vacuum serving. Minimized dead space and particle generation.	Very low differential pressure less than 0,2 psi. Minimized dead space and particle generation.
<b>Operating pressure</b>	7 - 44 psi	Customer specified	7 - 44 psi	7 - 44 psi	Customer specified
<b>Operating Temperature °C</b>	5 - 50°C	5 - 50°C	5 - 50°C	5 - 80°C / 150°C (1680F)	5 - 80°C / 150°C (1670F)
<b>Response Time</b>	< 2 sec	< 1 sec	< 1 sec	0,7 - 1,2 sec	0,7 - 1,2 sec
<b>Control Valve</b>	NC or NC piezoelectric	NO or NC piezoelectric	NO or NC piezoelectric	NO or NC piezoelectric	NO piezoelectric
<b>Leak integrity</b>	1x10 <sup>-10</sup> atm-cc/sec of He (rubber sealing 1x10 <sup>-8</sup> )"	1x10 <sup>-10</sup> atm-cc/sec of He	1x10 <sup>-10</sup> atm-cc/sec of He	1x10 <sup>-10</sup> atm-cc/sec of He	1x10 <sup>-10</sup> atm-cc/sec of He

## Overview FX- and G-Series **SAM**

Normal operating pressure: 7 - 44 psi, Operating temperature: 5 - 50°C, Response time:< 1 sec, Surface treatment: Special electropolishing.

Model	SFC 1480/2480 FX	SFC 1480/2480 G1	SFC 1480/2480 G2	SFC 1480/2480 G3	SFC 1480/2480 G4
<b>Type</b>	Digital MFC/MFM	Digital MFC/MFM	Digital MFC/MFM	Digital MFC/MFM	Digital MFC/MFM
<b>MG/MR function</b>	x	x	x	x	x
<b>PI function</b>	x	x		x	x
<b>Valve shut-off function</b>			x	x	x
<b>Flow rate verification function</b>					x
<b>LCD display unit</b>		x		x	x
<b>Flow range</b>	0,001 - 50 SLM	0,005 - 50 SLM	0,005 - 50 SLM	0,005 - 0,05 SLM	0,005 - 50 SLM
<b>Communication</b>	DeviceNet™, RS-485, RS232 and analog	DeviceNet™, RS-485, RS232 and analog	DeviceNet™, RS-485, RS232 and analog	DeviceNet™, RS-485, RS232 and analog	DeviceNet™, RS-485, RS232 and analog
<b>Specialties</b>	Extremely reliable thermal coil sensor. Reduced particular contamination, high corrosion resistance, outstanding control performance. LCD display (temp, pressure, set, output)	PI function reduces gas supply inlet pressure fluctuation influence in the actual flow rate. LCD display (temp, pressure, set, output)	100% shut-off valve reduces gas surge into a chamber and gas purge time, provides productivity improvements. LCD display (temp, pressure, set, output)	Including features of G1 + G2; G3 offers a LCD display unit. LCD display (temp, pressure, set, output)	Outstanding top model offering all available functions. LCD display (temp, pressure, set, output)
<b>Control valve</b>	NO or NC piezoelectric	NO pneumatic	NO pneumatic	NO pneumatic	NO pneumatic
<b>Sealing</b>	metal design	metal design	metal design	metal design	metal design
<b>Leak integrity</b>	1x10 <sup>-10</sup> atm-cc/sec of He	1x10 <sup>-10</sup> atm-cc/sec of He	1x10 <sup>-10</sup> atm-cc/sec of He	1x10 <sup>-10</sup> atm-cc/sec of He	1x10 <sup>-10</sup> atm-cc/sec of He
<b>Connections</b>	W/C/H1G seal, 1/4" HMJ male	W/C/H1G seal, 1/4" HMJ male	W/C/H1G seal	W/C/H1G seal	W/C/H1G seal
<b>Alarm and diagnostics</b>	Comprehensive alarm and diagnostic functions	Comprehensive alarm and diagnostic functions, LED display	Comprehensive alarm and diagnostic functions, LED display	Comprehensive alarm and diagnostic functions, LED display	Comprehensive alarm and diagnostic functions, LED display

## Digital/Analog Mass Flow Controllers series G1 - G4

From the release of the first SAM® Flow controller, SAM® controllers continue in the tradition of perfection. Now SAM® brand G models satisfy the demand for the next generation of semiconductor production meeting or exceeding the next generation of requirements.

The MG/MR function handles two or more gases and ranges and reduces the capital investment and inventory liability. Even though G series provide a flow rate accuracy guarantee for the actual gas type, the precision and response of the flow can be maintained after any change. PI function reduces gas supply inlet pressure fluctuation influence on flow rate by sensing changes with a supplementary incorporated pressure sensor. From there control valve will be kept opening at optimum level.

Usually a pneumatic control valve is installed up and down stream to shut of gas stream completely if necessary. But sometimes leaking gas may be left over in-between. To avoid unwanted gas surge because of that, a positive shut-off valve function (VSO) with an ultra-small pneumatic valve linked to the control valve has been integrated.

Wherever process margins are tight and the interruption of ongoing processes is not possible, MFC's performance must be possible to be evaluated without removing it from the gas circuit. In line flow verification and self calibration functions (FVF) turns that demand into reality, integrating a verification system (tank and integrated pressure

### Features

- Guaranteed control accuracy
- Integrated pressure/temperature sensors
- Extremely corrosion-proof with stable control waveform NiCo alloy diaphragm
- Diaphragm direct sealing valve
- Unique, special electro-polished surfaces
- High corrosion resistance
- Comprehensive alarm functions

sensor and side inlet valve) and reporting deviations by comparing measured with previously recorded data. By that, risks may be identified soonest without causing damage and the MFC's life might be prolonged.

An LCD display (temp, pressure, set, output) easifies any necessary control routines.

G series achieves superior reliability performance with < 0.5 % zero drift over one year and superior repeatability of 0.01 % of full scale. Comprehensive communication and control functions include flow, valve and CPU alarms, gas-flow totalizing and ramping control, system override capabilities and in-situ gas and range customization. G's outstanding technology capabilities reduces overall costs by cutting inventory requirements.

### Benefits

- Outstanding repeatability, accuracy and stability
- Impressive alarm and diagnostic functions
- Comprehensive communication and control
- Superior reliability flexibility
- Greater flexibility and lower cost of ownership

### Highlights

G1 has achieves superior reliability performance with < 0.5 % zero drift over one year and superior repeatability of 0.01 % of full scale. Comprehensive communication and control functions include flow, valve and CPU alarms, gas-flow totalizing and ramping control, system override capabilities and in-situ gas and range customization. G's outstanding technology capabilities reduces overall costs by cutting inventory requirements.

## Series 1480/2480 G1

G1 models satisfy the demand for the next generation of semiconductor production.

### Features

- Multi-gas, multi-range selection
- Pressure-insensitive operation  
Valve shut-off function
- LCD display (temp, pressure, set, output) easifies control routines

### Implemented Functions

**MG/MR PI**

### Benefits

- Great inlet pressure change insensitivity
- Allows one mass flow controller to handle two or more gas types and ranges
- The need for dedicated devices is reduced to only a few models
- Reduces the capital investment and inventory liability
- Performance maintained after gas change



## Series 1480/2480 G2

G2 models satisfy the demand for the next generation of semiconductor production.

### Features

- Multi-gas, multi-range selection
- Valve shut-off function
- Self calibration function

### Implemented Functions

**MG/MR VSO**



### Benefits

- Shortening gas purge time needed
- Complete gas shut-off
- Gas leaking volume 1/10 related to that with a standard combination (MFC and pneumatic valve)
- Reduction of gas surge
- Allows one mass flow controller to handle two or more gas types and ranges
- The need for dedicated devices is reduced to only a few models
- Reduces the capital investment and inventory liability
- Performance maintained after gas change

## Series 1480/2480 G3

G3 models satisfy the demand for the next generation of semiconductor production

### Features

- Multi-gas, multi-range selection
- Pressure-insensitive operation PI
- LCD display (temp, pressure, set, output) easifies control routines
- Self calibration function

### Benefits

- Great inlet pressure change insensitivity
- Allows one mass flow controller to handle two or more gas types and ranges
- The need for dedicated devices is reduced to only a few models

- Reduces the capital investment and inventory liability
- Performance maintained after gas change
- Shortening gas purge time needed
- Complete gas shut-off
- Gas leaking volume 1/10 related to that with a standard combination (MFC and pneumatic valve)
- Reduction of gas surge
- Allows one mass flow controller to handle two or more gas types and ranges
- The need for dedicated devices is reduced to only a few models
- Reduces the capital investment and inventory liability
- Performance maintained after gas change

Implemented Functions

**MG/MR PI VSO**



**DN**

## Series 1480/2480 G4

G4 models is **the most advanced MFC** meeting or exceeding the demand of the actual and also the next generation of semiconductor production.

### Features

- Multi-gas, multi-range selection
- Pressure-insensitive operation
- Valve shut-off function
- In-line integrated flow verification system
- Self calibration function
- LCD display (temp, pressure, set, output) easifies control routines

### Benefits

- Great inlet pressure change insensitivity
- Allows one mass flow controller to handle two or more gas types and ranges
- The need for dedicated devices is reduced to only a few models
- Reduces the capital investment and inventory liability
- Performance maintained after gas change
- Shortening gas purge time needed
- Complete gas shut-off

Implemented Functions

**MG/MR PI VSO FVF**



**DN**

## The GCE Group

The GCE Group is Europe's leading gas-equipment company and organized according to four main business areas: Process Applications, Cutting and Welding, Medical and High Purity.

Today's product portfolio corresponds to a large variety of applications, from simple pressure regulators and blowpipes for Cutting and Welding to sophisticated gas supply systems for medical and electronics industry applications. GCE's portfolio includes a large number of brands such as Butbro, Charledave, DruVa, Mediline, Mujelli, Propaline, Rhöna and Sabre Medical, which are

leaders within their own respective regional markets and applications.

The GCE Group's headquarters are located in Malmö, from our central stock location in Prague we service more than 8,000 customers across the world.

Founded in 1968 the group now has in total 18 subsidiaries located in China, Czech Republic, France, Germany, Hungary, India, Italy, Panama, Poland, Portugal, Romania, Russia, Spain, Sweden and the UK, with additional local sales offices in Austria, Denmark and the

Netherlands representing an almost unequalled wealth of experience of gas supply handling and device.

In addition to certification according to the ISO 9001 quality standard, products are tested and certified by BAM, BSI, Norske Veritas, US DOT, UL, CEN, DIN and SIS, among others.

The GCE Group has grown rapidly since its establishment and is leading the restructuring of the European gas-equipment industry through mergers and acquisitions. The group currently employs approximately 900 people.

## Calibration - Service - Maintenance: Precise, quick and close to our customers

### Repair, cleaning and calibration of MFC's

Based upon a long experience in solid state, plasma and high-frequency technologies the laboratory's main purposes of activity are technological and technical sophisticated solutions as well as quick, professional assistance especially by:

- Technology acceptance test in our facilities
- Cooperation with leading equipment suppliers for the vacuum thin film technology and related components as for example high frequency power supplies
- Collaboration with Research centers and Universities with the latest measuring and analysis equipment.

### Facilities, Equipment

Clean rooms for assembly and repair of processing equipment.



### Measuring equipment and power supplies

- RF / VHF measuring instruments.
- RF / VHF power supply up to 100 MHz.
- Optical emissions spectroscopy.
- Temperature array sensors.
- Vacuum measuring instruments.

### Service and Support for our customers

- Repair, change calibration, re-calibration, full-service, upgrade-service.
- Repair of regenerated and used devices.
- 24 h service seven days a week.



## GCE worldwide - We are close to you !

### Germany

GCE GmbH  
Weyherser Weg 8  
36043 Fulda  
Phone: +49 (0)661-8393-0  
Fax: +49 661 8393 25  
sales.de@gcegroup.com

### Czech Republic

GCE Trade s.r.o.  
Zizkova 381  
CZ-583 01 Chotebor  
Phone: +420 569 661 122  
Fax: +420 569 661 107  
sales.cz@gcegroup.com

### France

GCE S.a.s.  
70, rue du PUIITS CHARLES  
BP N° 40110  
FR-58403 La Charité-sur-Loire  
Phone: +33/3 86 69 46 00  
Fax: +33/3 86 70 09 15  
sales.fr@gcegroup.com

### Hungary

GCE Hungária Kft.  
II. Rákóczi Ferenc út 90/B  
H-2314 Halásztelek  
+36 (24) 521 200  
Fax: +36 (24) 521 201  
sales.hu@gcegroup.com

### Italy

GCE Mujelli spa  
Via F. Cervi, 11  
37036 San Martino B.A. (VR)  
Phone: +39 045 878 0 525  
Fax: +39 045 878 0 750  
sales.it@gcegroup.com

### Poland

GCE Sp z o.o.  
ul. Drapińska 12  
03-581 Warszawa  
Phone: +48 22 511 23 57  
Fax: +48 22 677 70 90  
sales.pl@gcegroup.com

### Portugal

GCE Portugal  
Rua de Vila Boa, n.º10, casa 16  
PT-4520-160 Sta Maria da Feira  
Phone: +351 256 373 682  
Fax: +351 256 378 260  
sales.pt@gcegroup.com

### Romania

GCE Romania S.R.L  
22, Al.Puskin Street, Ap.1,  
Bucharest 1, 011996  
Phone: +40 21 316 76 72  
Fax: +40 21 316 76 74  
sales.ro@gcegroup.com

### Russia

GCE Krass 000  
Russian Federation  
129343, Moscow,  
Urzhymkaya Street, no 4  
Phone: +7 495 745 26 99  
Fax: +7 495 745 26 90  
sales.ru2@gcegroup.com

### Spain

GCE Ibérica  
C/ San Romualdo 12-14 3º 5  
E-28037 Madrid  
Phone: +34 91 571 98 74  
Fax: +34 91 571 27 56  
sales.es@gcegroup.com

### Sweden

GCE Norden AB  
Källvattengatan 9  
200 21 Malmö  
Phone: +46-40-388300  
Fax: +46-40-388353  
sales.se@gcegroup.com

### United Kingdom & Ireland

GCE Ltd.  
Yew Tree Way, Stone Cross Park  
Golborne, Warrington WA3 3JD  
Phone: +44 (0)1942 29 29 50  
Fax: +44 (0)1942 29 29 77  
sales.gb@gcegroup.com

### India

GCE India Pvt Ltd.Headquarter  
'Prem-Bagh' 1st floor  
31 Benson Road, Benson Town  
Bangalore 560046, Karnataka  
Phone/Fax: +91 80 23631685  
gce.india@gcegroup.com

### P.R. China

No.4 Building, 318 Xiao Wan Road  
Fengxian District, Shanghai 201401,  
Phone: +86-21-37198408  
Fax: +86-21-37198617



Gas Control Equipment

[www.gcegroup.com](http://www.gcegroup.com)